

# MASSA

MODERN DESIGN & LIVING



BANYO KOLEKSİYONU  
BATHROOM COLLECTION

## ÖZELLEŐTİRME SEÇENEKLERİ

Massa üretim tekniklerinin doğası geređi, her parça müşterilerimizin ihtiyaç ve zevklerine göre özelleştirilebilir. Ancak bazı parçaların sınırlamaları olabilir ve bu, her özelleştirme talebinin teknik ekibimiz tarafından analiz edilmesi gerektiđi anlamına gelir.

sipariő edilen ürünler için tüm malzemeler Massa tarafından uygun şekilde tanımlanmadan, herhangi bir üründe üretim başlamayacaktır. siparişler için teslim süresi, tüm malzemeler uygun şekilde onaylandıktan sonra başlar.

## CUSTOMIZATION OPTIONS

Due to the nature of Massa manufacturing techniques, each piece can be customized to our customers' needs and tastes. However, some parts may have limitations, which means that every customization request means it needs to be analyzed by our technical team.

before all materials are properly identified by Massa for the ordered products, Production will not start on any product. The lead time for orders starts after all materials are properly approved.

# MAKSİMUM TASARIM ÖZELLİĐİ

maximum design freedom

MASSA şirketi ; çağdaş tasarım ve el işçiliği becerisini birleştirerek sektöre öncülük eden isim olmuştur. Doğal taş kullanımı markanın önerdiği iç tasarım çözümlerinin ifade aracı ve temeli olarak tasarlanmıştır. Prestijli kreasyonlar , benzersiz tasarımlar olarak öne çıkmaktadır.

MASSA company ; It has become a leader in the sector by combining its contemporary design and craftsmanship skills. The use of natural stone is designed as a means of expression and basis for interior design solutions proposed by the brand. Prestigious creations as unique designs stands out.









# Felicia

FELICIA COLLECTION













SALVATORI

















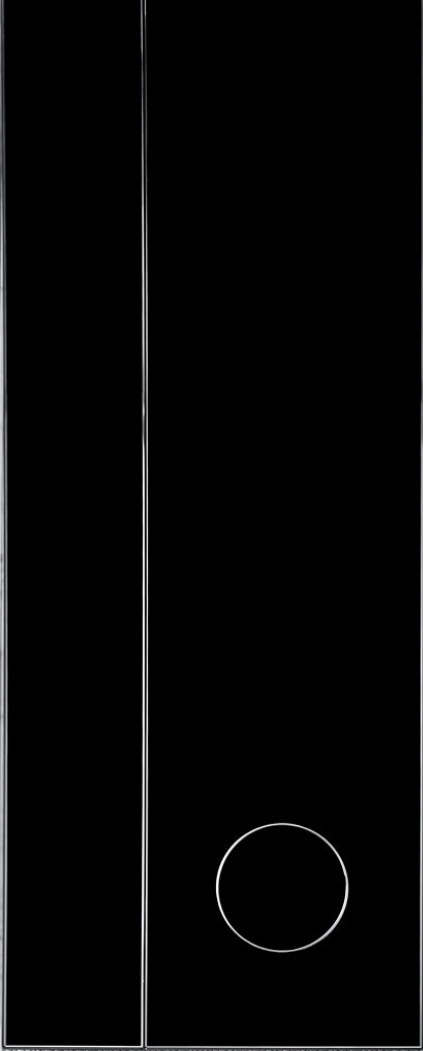



# BilgiFormu Nitelik Teknik

Information Form  
Qualification  
Technical

# Boyutlar

## Dimensions

89.4 × 46.1 × 20 cm  
35¼ × 18 ⅞ × 7⅞"

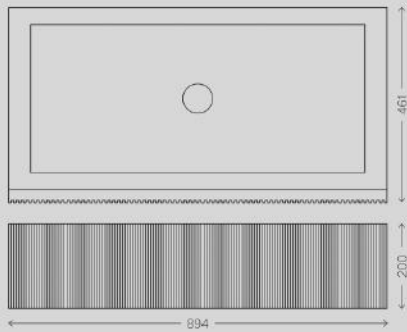

59.4 × 46.1 × 20 cm  
23¾ × 18 ⅞ × 7⅞"

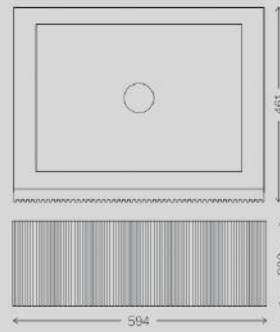

89.4 × 46.1 × 40 cm  
35¼ × 18 ⅞ × 15¾"

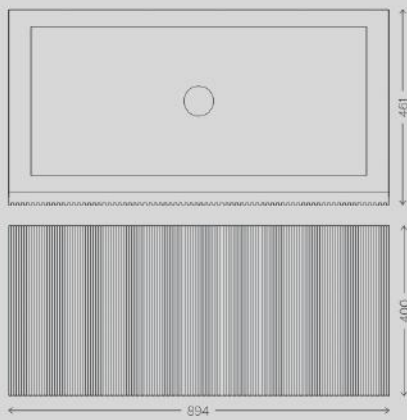

59.4 × 46.1 × 40 cm  
23¾ × 18 ⅞ × 15¾"

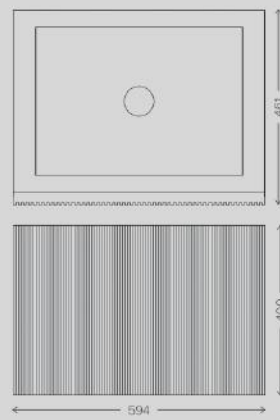

41.4 × 40.8 × 40.6 cm  
16¼ × 16⅞ × 16"

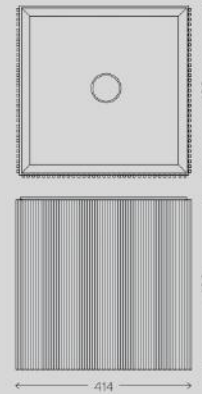

41.7 × 90.6 cm  
16¾ × 35½"

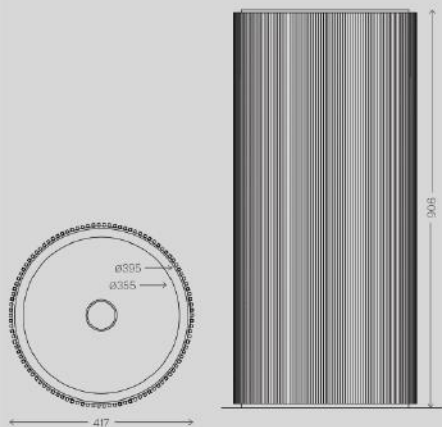

41.4 × 41.4 × 90.6 cm  
16¼ × 16¼ × 35½"

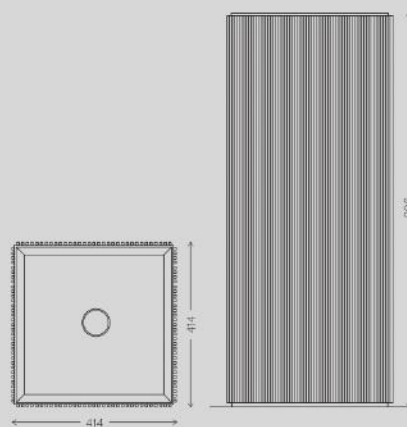

Boyutlar  
Dimensions

---

89.4 × 46.1 × 20 cm  
35¼ × 18½ × 7⅞"

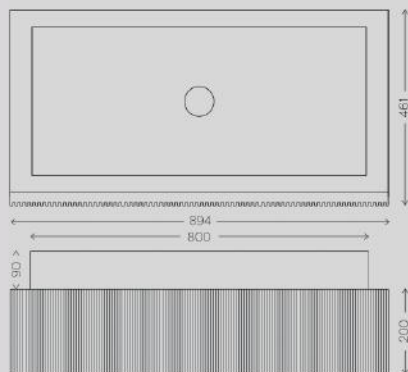

59.4 × 46.1 × 20 cm  
23¾ × 18½ × 7⅞"

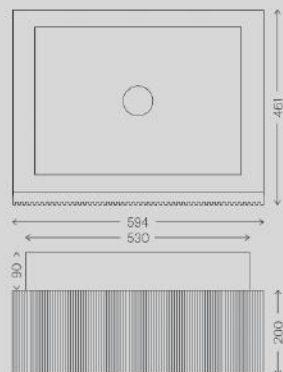

89.4 × 46.1 × 40 cm  
35¼ × 18½ × 15¾"

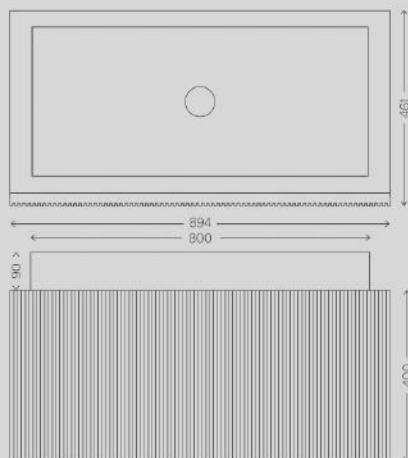

59.4 × 46.1 × 40 cm  
23¾ × 18½ × 15¾"

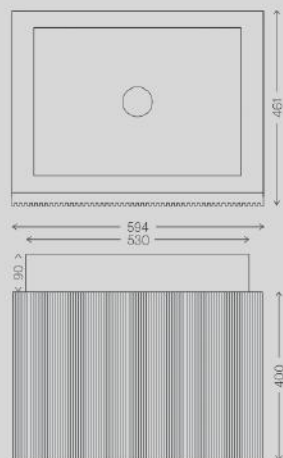



# Bianche

BIANCHE COLLECTION

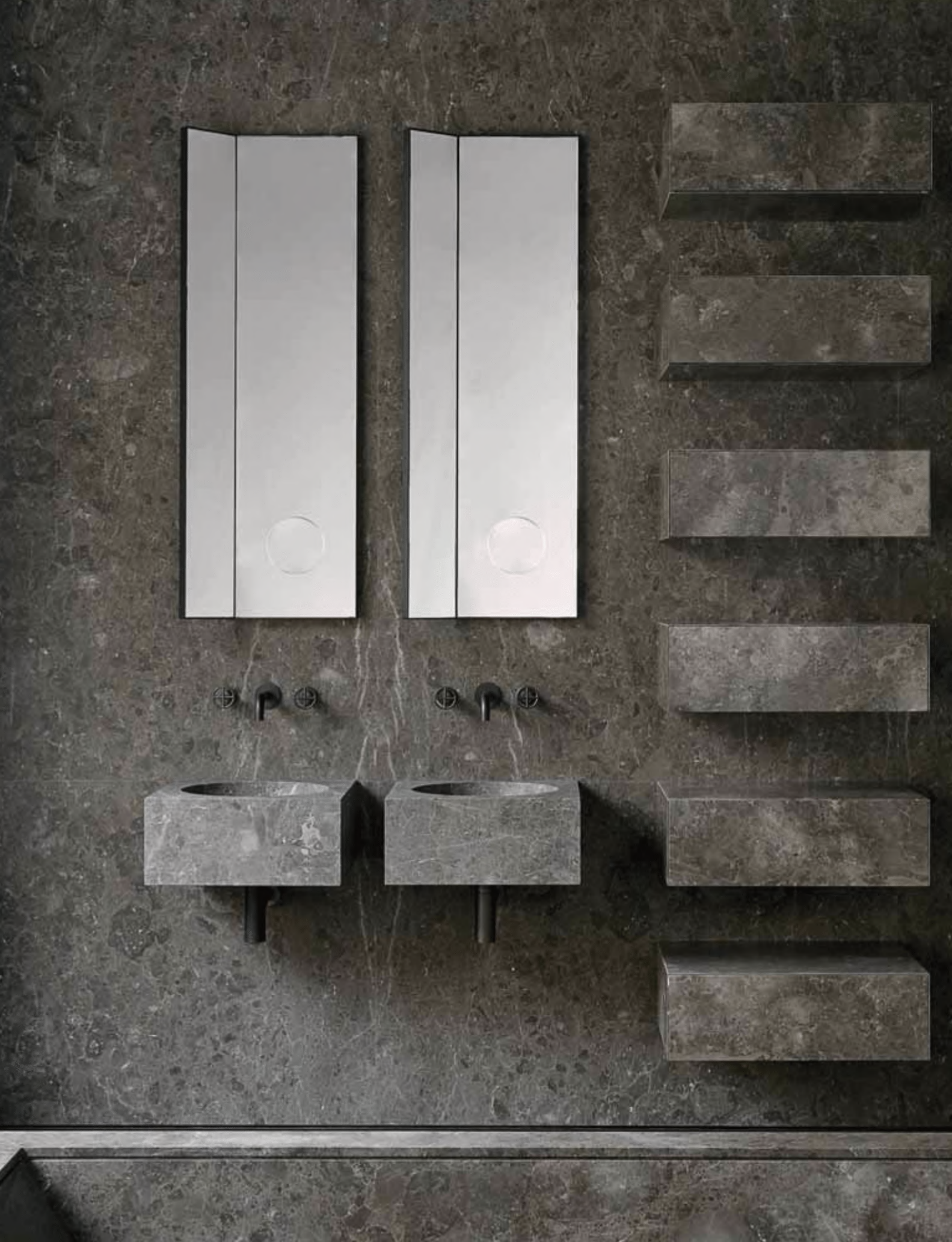













# BilgiFormu Nitelik Teknik

Information Form  
Qualification  
Technical

Boyutlar  
Dimensions

45 × 45 × 20 cm  
17¾ × 17¾ × 7⅞"

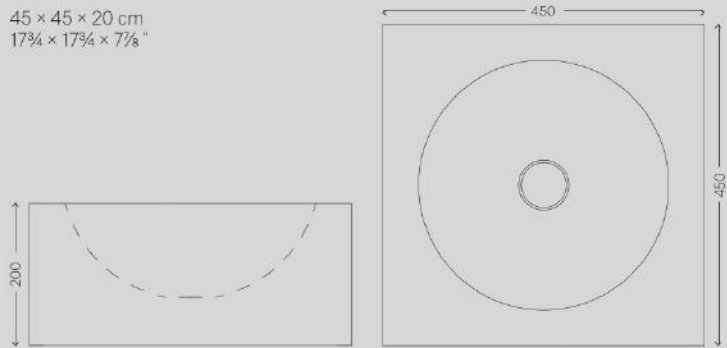

80 × 45 × 90 cm  
31½ × 17¾ × 35⅝"

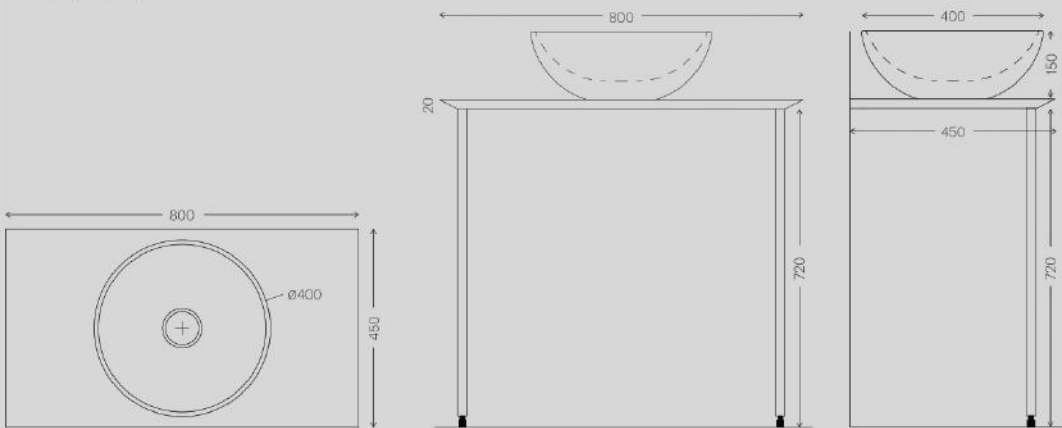

60 × 45 × 20 cm  
23¾ × 17¾ × 7⅞"



60 × 45 × 20 cm  
23¾ × 17¾ × 7⅞"

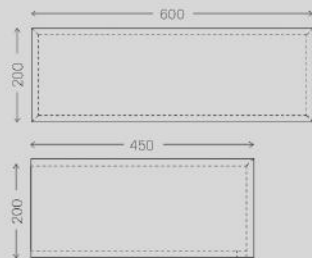

90 × 45 × 20 cm  
35⅝ × 17¾ × 7⅞"





# Tailor

TAILOR COLLECTION

















# BilgiFormu Nitelik Teknik

Information Form  
Qualification  
Technical

## Boyutlar Dimensions

120 × 40 × 55 cm  
47¼ × 15¾ × 21½"

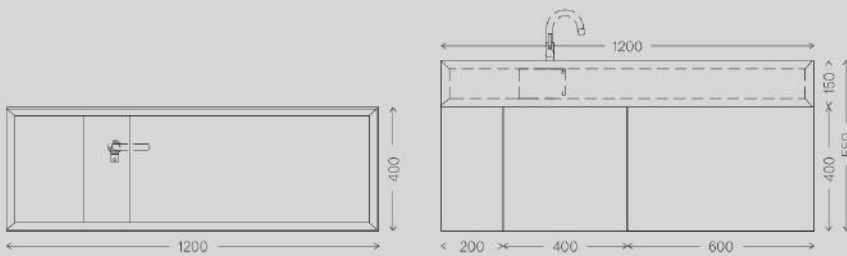

120 × 40 × 85 cm  
47¼ × 15¾ × 33½"

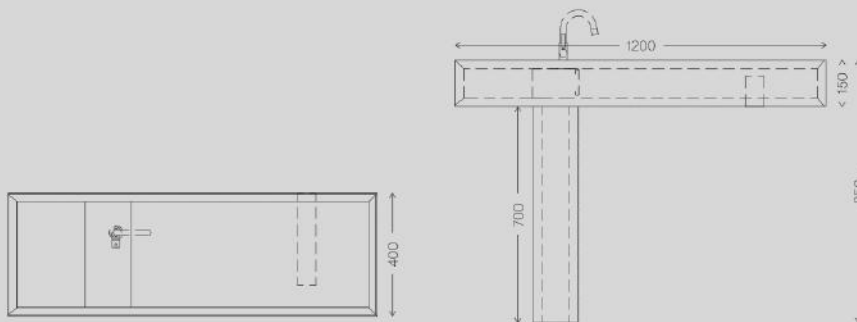

180 × 80 × 53.5 cm  
70¾ × 31½ × 21½"

28 cm  
11"

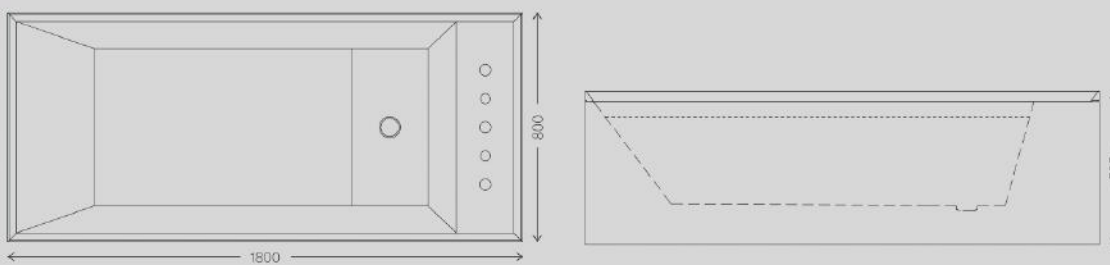

water capacity  
su kapasitesi  
235 litre  
235 litres



# William

WILLIAM COLLECTION







# BilgiFormu Nitelik Teknik

Information Form  
Qualification  
Technical



# Boyutlar Dimensions

82.2 × 48.3 × 85 cm  
32 1/8 × 19 × 33 1/2"

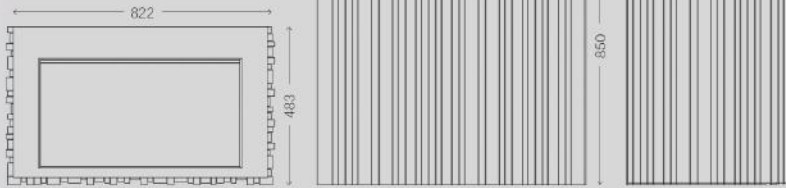

203.5 × 100 × 55 cm  
80 1/8 × 39 3/8 × 21 5/8"

30 cm  
11 3/4"

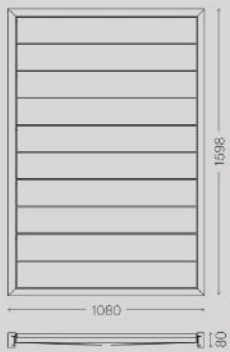
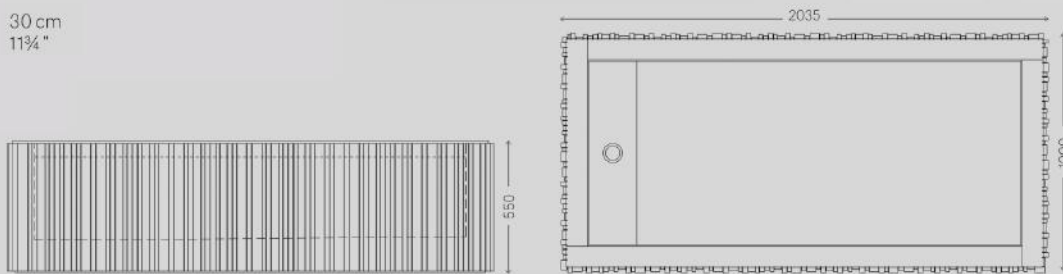

30.5 × 61 cm  
12 × 24"

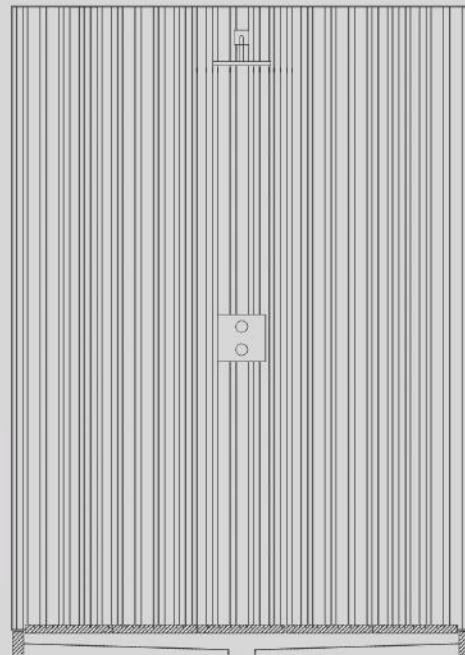
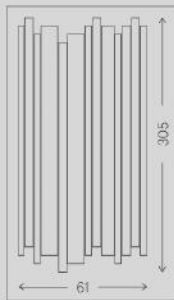

# Stiletto

STILETTO COLLECTION







SALVATORI















Pozzo



Zuppiera



Bacinella



Uovo

# BilgiFormu Nitelik Teknik

Information Form  
Qualification  
Technical



# Boyutlar

## Dimensions

**STILETTO 90**  
90 × 50 × 30cm  
35 $\frac{3}{8}$  × 19 $\frac{1}{8}$  × 11 $\frac{1}{8}$ "

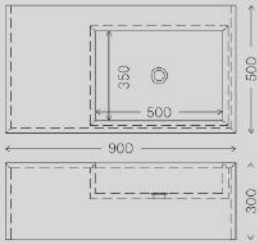

**STILETTO 120**  
120 × 50 × 30cm  
47 $\frac{1}{4}$  × 19 $\frac{1}{8}$  × 11 $\frac{1}{8}$ "

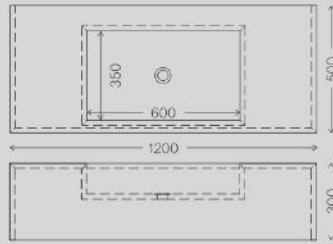

**STILETTO 150**  
150 × 50 × 30cm  
59 × 19 $\frac{1}{8}$  × 11 $\frac{1}{8}$ "

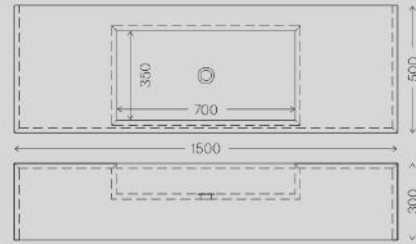

**STILETTO 180**  
180 × 50 × 30cm  
70 $\frac{3}{8}$  × 19 $\frac{1}{8}$  × 11 $\frac{1}{8}$ "

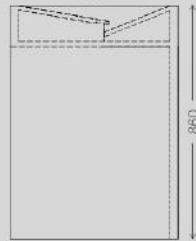
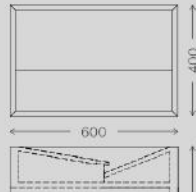
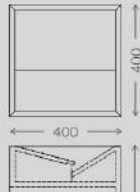
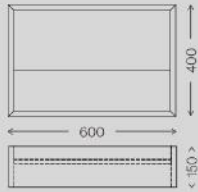
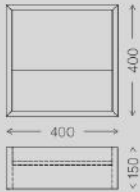
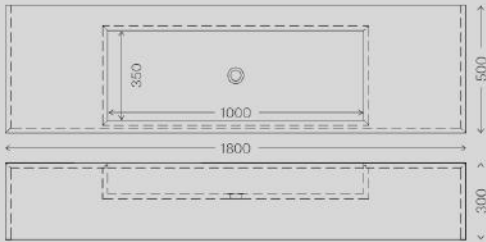

**POZZO**  
Ø46 × 20cm  
Ø18 $\frac{1}{8}$  × 7 $\frac{7}{8}$ "

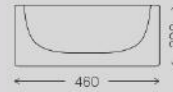

**ZUPPIERA**  
Ø40 × 15cm  
Ø15 $\frac{1}{8}$  × 5 $\frac{7}{8}$ "

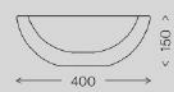

**BACINELLA**  
Ø40 × 15cm  
Ø15 $\frac{1}{8}$  × 5 $\frac{7}{8}$ "

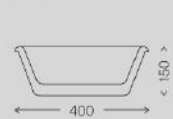

**UOVO**  
Ø41.4 × 26.5cm  
Ø16 $\frac{1}{8}$  × 10 $\frac{3}{8}$ "

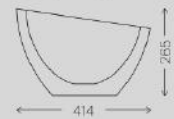

# Elisa

ELISA COLLECTION





























# BilgiFormu Nitelik Teknik

Information Form  
Qualification  
Technical



# Boyutlar Dimensions

Filo 3 | 80  
90 × 80 cm  
35½ × 31½"

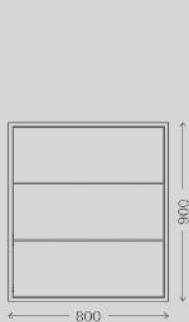

Filo 4 | 80  
119.8 × 80 cm  
47⅞ × 31½"



Filo 5 | 80  
149.6 × 80 cm  
58⅞ × 31½"

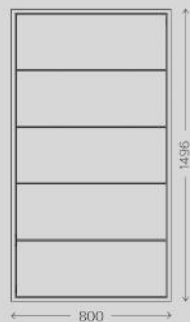

Filo 3 | 100  
90 × 100 cm  
35½ × 39⅝"

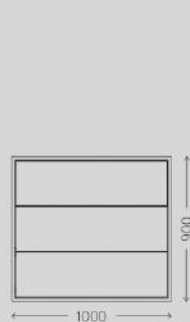

Filo 4 | 100  
119.8 × 100 cm  
47⅞ × 39⅝"



Filo 5 | 100  
149.6 × 100 cm  
58⅞ × 39⅝"

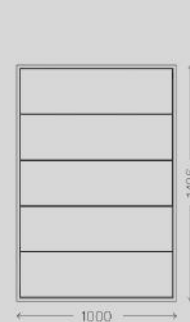

FILO 3 | 88  
98 × 88 cm  
38⅞ × 34⅞"

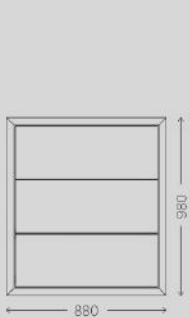

FILO 4 | 88  
127.8 × 88 cm  
50¼ × 34⅞"

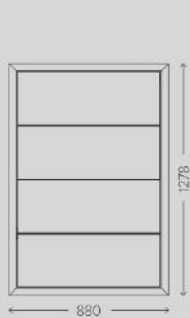

FILO 5 | 88  
157.6 × 88 cm  
62 × 34⅞"



FILO 3 | 108  
98 × 108 cm  
38⅞ × 42½"



FILO 4 | 108  
127.8 × 108 cm  
50¼ × 42½"



FILO 5 | 108  
157.6 × 108 cm  
62 × 42½"



# Millen

MILLEN COLLECTION









# BilgiFormu Nitelik Teknik

Information Form  
Qualification  
Technical

Boyutlar  
Dimensions

---

180 × 80 × 51.5 cm  
70<sup>7</sup>/<sub>8</sub> × 31<sup>1</sup>/<sub>2</sub> × 20<sup>1</sup>/<sub>4</sub> "

28 cm  
11 "

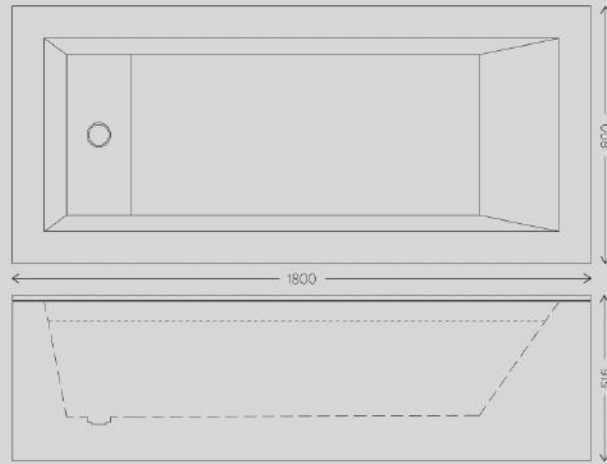





# KURULUM &BAKIM

Installation  
& Care



# KOLAY KURULUM

Easy Installation

## STEP1

PASLANMAZ ÇELİK TEPSİYİ  
KONUMLANDIRIN

## STEP2

ATIK SU BAĞLANTISINI  
OLUŞTURUN

## STEP3

ÇİTALARI TEPSİ ÜZERİNE  
YERLEŞTİRİN

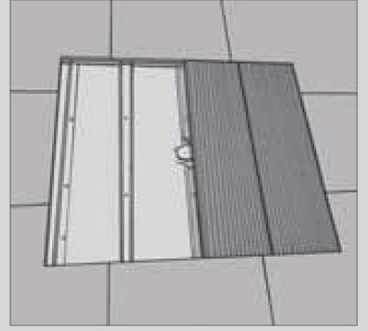
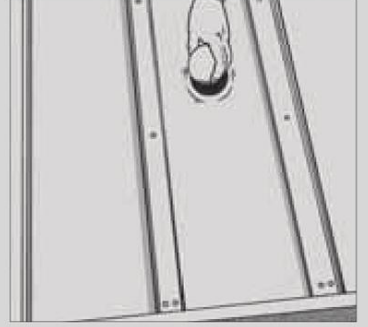
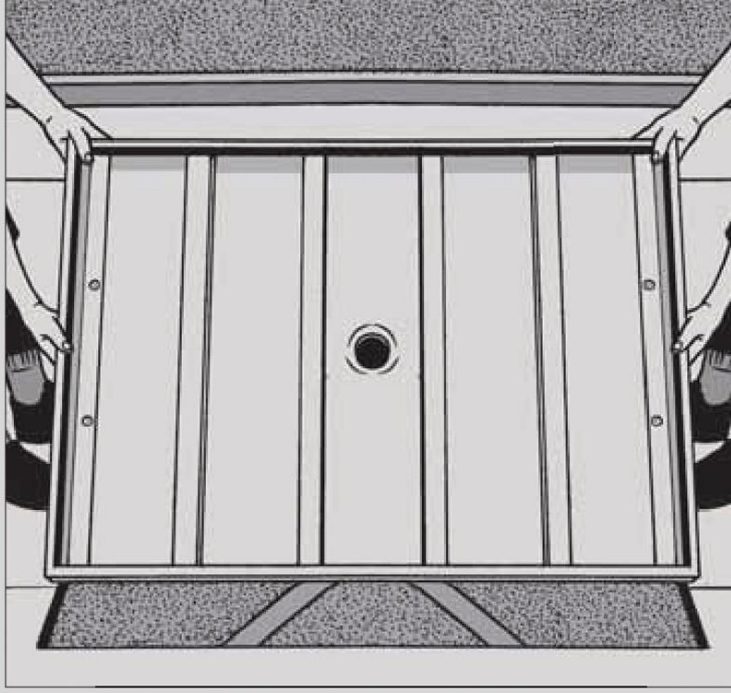

## STEP 1

Position the stainless steel tray.

## STEP 2

Connect the waste.

## STEP 3

Lay the slats onto the tray.

## STEP1

FİLO KİTİ DELİK ÜZERİNE  
TAKIN VE MEVCUT  
BORU SİSTEMİNE BAĞLA-  
YIN

## STEP2

ÇELİK TEPSİYİ  
ÜZERİNE YERLEŞTİRİN

## STEP2

ÇİTALARI TEPSİ ÜZERİNE  
YERLEŞTİRİN

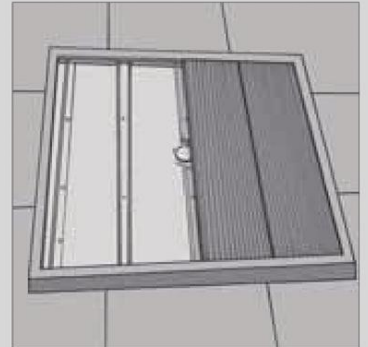
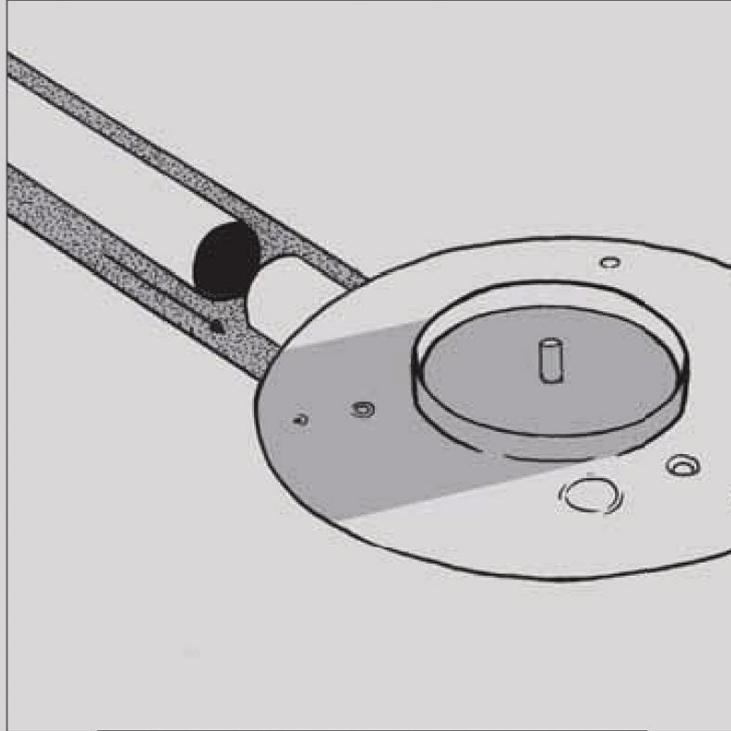

## STEP 1

Insert the waste provided in the  
Filo kit over the hole and connect  
to the existing pipe system.

## STEP 2

Place the steel tray over the waste.

## STEP 3

Lay the slats onto the tray.

#### TEMİZLİK & BAKIM

Yüzeylerin rutin bakımı için her zaman nötr temizleyiciler kullanın.

Taş yüzeyine zarar verebilecek sert ürünler kullanmayın.

Renk bozulmasına veya lekelenmeye neden olabileceğinden, sıcak yada soğuk nesnelere doğrudan doğal taş üzerine koymayın.

#### CLEANING & MAINTENANCE

Always use neutral cleaners for routine maintenance of surfaces.

Do not use hard products that can damage the stone surface.

Do not place hot or cold objects directly on natural stone as this may cause discoloration or staining.  
do not put



# MASSA

MODERN DESING & LIVING



Ofis - Office  
Merkez Mah. Rifat Sk. No:12/1 Avcılar-İSTANBUL  
+90 212 - 944 - 5595



[instagram.com / massamermer](https://www.instagram.com/massamermer)  
[www.massamermer.com](http://www.massamermer.com)  
[info@massamermer.com](mailto:info@massamermer.com)